

MOON

spazioli
wellness spaces.

Nueva línea  **WHITE LINE**
Perfilería en acabado Blanco

Ampliamos nuestra serie con perfilera blanca



MOON

MOON



• Ruedas regulables



• Tirador metálico.



• Guiador metálico



• Vierteaguas y remates metálicos























































• Cierre magnético a pared



• Esquinero cromado con perfilera blanca



• Herrajes cromo con perfilera a blanca

-  BRILLO
-  BRILLO
-  BRILLO
-  BRILLO
-  BLACK LINE
-  BRILLO
-  BRILLO
-  BRILLO
-  WHITE LINE
-  BLACK LINE
-  BRILLO
-  BRILLO
-  BRILLO
-  MATEADO
-  BRILLO
-  MATEADO
-  BRILLO
-  MATEADO
-  BLACK LINE
-  BRILLO
-  BRILLO
-  BRILLO
-  BLACK LINE
-  BRILLO
-  BLACK LINE
-  BRILLO
-  BRILLO
-  BLACK LINE
-  BRILLO
-  BRILLO
-  BLACK LINE
-  BRILLO
-  BLACK LINE
-  BRILLO
-  MATEADO
-  MATEADO
-  BLACK LINE
-  BRILLO
-  BRILLO
-  MATEADO
-  MATEADO
-  BLACK LINE
-  MATEADO
-  BLACK LINE
-  MATEADO
-  BLACK LINE
-  BRILLO
-  MATEADO
-  BLACK LINE
-  BRILLO
-  COBRE
-  BLACK LINE
-  BRILLO

- SOLID
- SIDE
- MOON
- STAR
- WALL
- SOLID
- SIDE
- MOON
- SUITE
- PASS
- DUNE
- FORUM
- NEXUS
- INFINITI
- ROLLING
- COMBI
- STAR
- HANDI
- FLEX
- NOVA
- OPEN
- QUADRO
- NATURE
- STYLE
- NEXUS
- TECHNICAL
- ROLLING
- INVISIBLE
- FRAME
- CASSONETTO
- CLICK
- PACK
- HIDRA
- DATOS TÉCNICOS
- DECORADOS

NOON

MOON

MOON



WHITE LINE
Pantallas en acabado Blanco

MO2

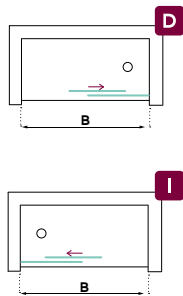
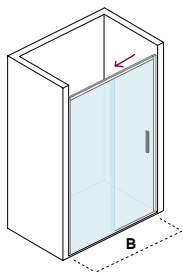

Características

- 1 Fijo y 1 puerta corredera
- Espesor vidrio 6mm
- Tratamiento antical a dos caras
- Impresión digital, consultar pag:274
- Altura 1950. Máxima hasta 2200mm
- Ruedas con ajuste vertical
- Cierre magnético
- Ancho máximo de la puerta 855 mm
- Mampara reversible en opción G0

| Rango de medida B | G0 Transparente | | G1 Mate, Extraclaro, Gris, Bronce | | G2 Espejo, Negro | |
|----------------------|--------------------|-------------------------|--------------------------------------|-------------------------|---------------------|-------------------------|
| | BRILLO | BLAK LINE WHITE LINE | BRILLO | BLAK LINE WHITE LINE | BRILLO | BLAK LINE WHITE LINE |
| Hasta- 110 | 369 | 424 | 465 | 534 | 498 | 572 |
| 110 - 120 | 386 | 444 | 487 | 560 | 521 | 600 |
| 120 - 130 | 405 | 466 | 510 | 587 | 546 | 628 |
| 130 - 140 | 422 | 486 | 532 | 612 | 570 | 656 |
| 140 - 150 | 441 | 507 | 555 | 639 | 595 | 684 |
| 150 - 160 | 458 | 527 | 578 | 664 | 619 | 712 |
| 160 - 170 | 477 | 548 | 601 | 691 | 644 | 740 |
| 170 - 180 | 494 | 569 | 623 | 716 | 667 | 768 |
| 180 - 190 | 513 | 590 | 646 | 743 | 692 | 796 |
| 190 - 200 | 530 | 610 | 668 | 769 | 716 | 824 |

Opciones

| Cambio de tirador por uñero, +30 | En bañera, h=1500 al mismo precio | Incremento altura, +5% cada 5 cm | Recortes especiales en el vidrio, +90 | Impresión digital personalizada, ver pag:274 |
|----------------------------------|-----------------------------------|----------------------------------|---------------------------------------|--|
| | | | | |
| | | | | Opción A Opción B Opción C |



WHITE LINE

NOON

MO2V

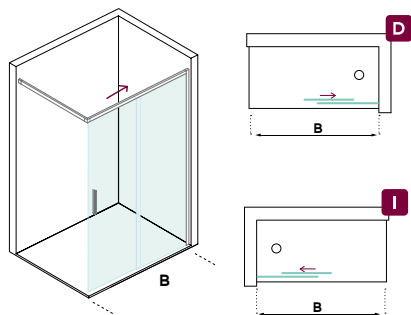

| Rango de medida B | G0 Transparente | | G1 Mate, Extraclaro, Gris, Bronce | | G2 Espejo, Negro | |
|-------------------|--------------------|-------------------------|--------------------------------------|-------------------------|---------------------|-------------------------|
| | B BRILLO | BLAK LINE WHITE LINE | B BRILLO | BLAK LINE WHITE LINE | B BRILLO | BLAK LINE WHITE LINE |
| Hasta- 100 | 347 | 398 | 437 | 502 | 468 | 538 |
| 100 - 110 | 362 | 417 | 456 | 525 | 489 | 562 |
| 110 - 120 | 381 | 438 | 480 | 552 | 514 | 591 |
| 120 - 130 | 399 | 459 | 503 | 578 | 539 | 619 |
| 130 - 140 | 417 | 480 | 526 | 605 | 563 | 648 |

Características

- 1 Fijo y 1 puerta corredera
- Espesor vidrio 6mm
- Tratamiento antical a dos caras
- Impresión digital pag:274
- Altura 1950. Máxima hasta 2200
- Ruedas con ajuste vertical
- Ancho máximo de la puerta 500 mm
- Mampara reversible en opción G0

| Opciones | | | | | |
|----------------------------------|-------------------|----------------------------------|----------------------------------|---------------------------------------|---|
| Cambio de tirador por uñero, +30 | Tirador blanco+45 | En bañera,h=1500 al mismo precio | Incremento altura, +5% cada 5 cm | Recortes especiales en el vidrio, +90 | Impresión digital personalizada,ver pag:274 |
| | | | | | |
| | | | | | Opcion A Opcion B Opcion C |

MOON



WHITE LINE
Perfiles en acabado Blanco





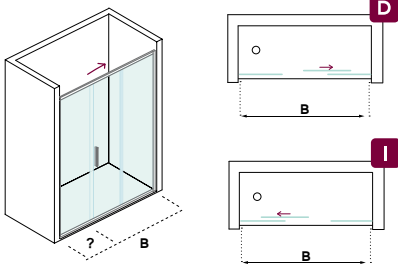



MOON

MO3





Características

-  2 Fijos y 1 puerta central corredera
-  Espesor vidrio 6mm
-  Tratamiento antical a dos caras
-  Impresión digital, consultar pag:274
-  Altura 1950. Máxima hasta 2200mm
-  Ruedas con ajuste vertical
-  Ancho máximo de la puerta 855 mm
-  Mampara reversible en opción G0

| Rango de medida B | G0 Transparente | | G1 Mate, Extraclaro, Gris, Bronce | | G2 Espejo, Negro | |
|----------------------|--|--|--|--|--|--|
| |  BRILLO |  BLAK LINE  WHITE LINE <small>Perfiles en acabado Blanco</small> |  BRILLO |  BLAK LINE  WHITE LINE <small>Perfiles en acabado Blanco</small> |  BRILLO |  BLAK LINE  WHITE LINE <small>Perfiles en acabado Blanco</small> |
| Hasta- 140 | 497 | 572 | 627 | 721 | 672 | 772 |
| 140 - 150 | 515 | 592 | 649 | 746 | 695 | 800 |
| 150 - 160 | 531 | 611 | 670 | 770 | 717 | 825 |
| 160 - 170 | 549 | 631 | 692 | 795 | 741 | 852 |
| 170 - 180 | 567 | 651 | 714 | 821 | 765 | 879 |
| 180 - 190 | 583 | 670 | 735 | 845 | 787 | 905 |
| 190 - 200 | 598 | 688 | 754 | 867 | 808 | 929 |

Opciones

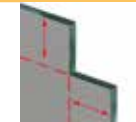
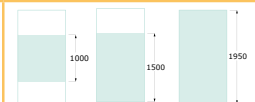
| Cambio de tirador por uñero, +30 | En bañera, h=1500 al mismo precio | Incremento altura, +5% cada 5 cm | Recortes especiales en el vidrio, +90 | Impresión digital personalizada, ver pag:274 |
|---|---|--|---|---|
|  |  |  |  |  Opción A Opción B Opción C |









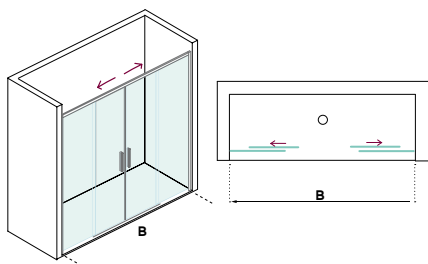

WHITE LINE
Perfiles en acabado blanco









NOON



MO4



Características

-  2 Fijos y 2 puertas correderas
-  Espesor vidrio 6mm
-  Tratamiento antical a dos caras
-  Impresión digital, consultar pag:274
-  Altura 1950. Máxima hasta 2200mm
-  Ruedas con ajuste vertical
-  Cierre magnético
-  Ancho máximo de la puerta 855 mm
-  Mampara reversible en opción G0

| Rango de medida B | G0 Transparente | | G1 Mate, Extraclaro, Gris, Bronce | | G2 Espejo, Negro | |
|-------------------|--|--|--|--|--|--|
| |  B BRILLO |  BLAK LINE  WHITE LINE <small>Perfiles en acabado blanco</small> |  B BRILLO |  BLAK LINE  WHITE LINE <small>Perfiles en acabado blanco</small> |  B BRILLO |  BLAK LINE  WHITE LINE <small>Perfiles en acabado blanco</small> |
| Hasta- 140 | 531 | 611 | 669 | 769 | 717 | 824 |
| 140 - 150 | 550 | 633 | 693 | 797 | 743 | 854 |
| 150 - 160 | 568 | 653 | 716 | 823 | 767 | 882 |
| 160 - 170 | 586 | 674 | 738 | 849 | 791 | 910 |
| 170 - 180 | 605 | 696 | 762 | 877 | 817 | 939 |
| 180 - 190 | 624 | 718 | 786 | 904 | 842 | 969 |
| 190 - 200 | 639 | 735 | 805 | 926 | 863 | 992 |

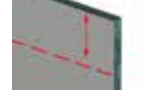
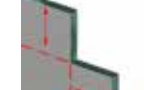
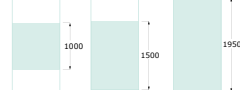
| Opciones | | | | |
|---|---|--|---|---|
| Cambio de tirador por uñero, +60 | En bañera, h=1500 al mismo precio | Incremento altura, +5% cada 5 cm | Recortes especiales en el vidrio, +90 | Impresión digital personalizada, ver pag:274 |
|  |  |  |  |  |
| | | | | Opcion A Opcion B Opcion C |

MOON







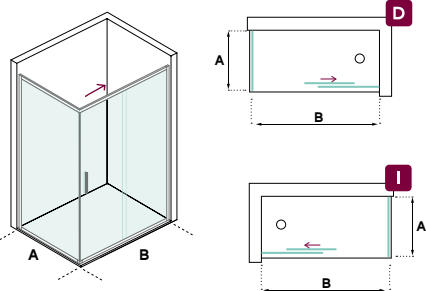



MOON

MO3A



Características

-  2 Fijos y 1 puerta corredera
-  Espesor vidrio 6mm
-  Tratamiento antical a dos caras
-  Impresión digital, consultar pag:274
-  Altura 1950. Máxima hasta 2200mm
-  Ruedas con ajuste vertical
-  Cierre magnético
-  Ancho máximo de la puerta 855 mm
-  Mampara reversible en opción G0

| Rango de medida A+B | G0 Transparente | | G1 Mate, Extraclaro, Gris, Bronce | | G2 Espejo, Negro | |
|------------------------|--|---|--|---|--|---|
| |  BRILLO |  BLAK LINE Puffirris en acabado Blanco  WHITE LINE Puffirris en acabado Blanco |  BRILLO |  BLAK LINE Puffirris en acabado Blanco  WHITE LINE Puffirris en acabado Blanco |  BRILLO |  BLAK LINE Puffirris en acabado Blanco  WHITE LINE Puffirris en acabado Blanco |
| Hasta- 180 | 529 | 609 | 667 | 767 | 714 | 822 |
| 180 - 190 | 547 | 629 | 689 | 793 | 739 | 850 |
| 190 - 200 | 568 | 653 | 715 | 823 | 767 | 881 |
| 200 - 210 | 585 | 672 | 737 | 847 | 789 | 907 |
| 210 - 220 | 601 | 691 | 758 | 871 | 812 | 933 |
| 220 - 230 | 618 | 711 | 779 | 895 | 834 | 959 |
| 230 - 240 | 635 | 730 | 800 | 920 | 857 | 985 |
| 240 - 250 | 653 | 751 | 822 | 946 | 881 | 1013 |
| 250 - 260 | 670 | 770 | 844 | 970 | 904 | 1039 |
| 260 - 270 | 685 | 788 | 863 | 992 | 925 | 1063 |
| 270 - 280 | 704 | 810 | 887 | 1020 | 951 | 1093 |
| 280 - 290 | 725 | 834 | 913 | 1050 | 979 | 1125 |
| 290 - 300 | 744 | 856 | 938 | 1078 | 1005 | 1155 |

Opciones

| | | | | |
|---|---|--|---|---|
| Cambio de tirador por uñero, +30 | En bañera, h=1500 al mismo precio | Incremento altura, +5% cada 5 cm | Recortes especiales en el vidrio, +90 | Impresión digital personalizada, ver pag:274 |
|  |  |  |  |  Opción A Opción B Opción C |





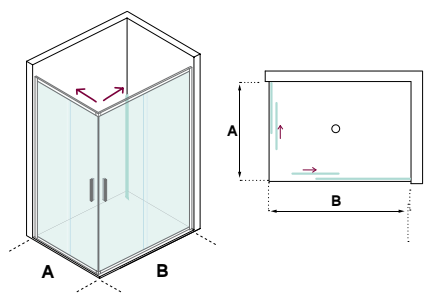

MO4A



Características

-  2 Fijos y 2 puertas correderas
-  Espesor vidrio 6mm
-  Tratamiento antical a dos caras
-  Impresión digital, consultar pag:274
-  Altura 1950. Máxima hasta 2200mm
-  Ruedas con ajuste vertical
-  Cierre magnético
-  Ancho máximo de la puerta 600 mm

| Rango de medida A+B | G0 Transparente | | G1 Mate, Extraclaro, Gris, Bronce | | G2 Espejo, Negro | |
|---------------------|---|---|---|---|---|---|
| |  |  |  |  |  |  |
| Hasta - 150 | 512 | 589 | 645 | 742 | 691 | 795 |
| 150 - 160 | 528 | 607 | 665 | 765 | 712 | 819 |
| 160 - 170 | 543 | 625 | 685 | 787 | 734 | 844 |
| 170 - 180 | 559 | 643 | 704 | 810 | 755 | 868 |
| 180 - 190 | 575 | 661 | 724 | 833 | 776 | 892 |
| 190 - 200 | 591 | 679 | 744 | 856 | 797 | 917 |
| 200 - 210 | 606 | 697 | 764 | 879 | 819 | 941 |
| 210 - 220 | 622 | 715 | 784 | 901 | 840 | 966 |
| 220 - 230 | 638 | 734 | 804 | 924 | 861 | 990 |
| 230 - 240 | 654 | 752 | 824 | 947 | 882 | 1015 |
| 240 - 250 | 669 | 770 | 843 | 970 | 904 | 1039 |
| 250 - 260 | 685 | 788 | 863 | 993 | 925 | 1064 |

Opciones

| | | | | |
|---|---|--|---|---|
| Cambio de tirador por uñero, +60 | En bañera, h=1500 al mismo precio | Incremento altura, +5% cada 5 cm | Recortes especiales en el vidrio, +90 | Impresión digital personalizada, ver pag:274 |
|  |  |  |  |  |